



# RM-K series

## Metal Waterproof Push Pull Self-locking Connector

*K series has same insulator and contact configuration as B series:*

- *Secure high performance push pull self-locking system*
- *High pin density contributing to equipment miniaturization*
- *Alignment Key and Polarized Keying System to avoid cross-interface*
- *Sealed up to IP68*
- *360° EMC shielded*
- *Robust and shock resistant designs*
- *Functional in a wide temperature range from -50°C to +250°C*
- *Available solder , PCB and right angle PCB contact*



# RM-K series

## Plugs



FGG



FGG



FPG

---

## Receptacles



EGG



EEG



EEG



HGG

---



PHG



PHG

---

## Part Numbering System

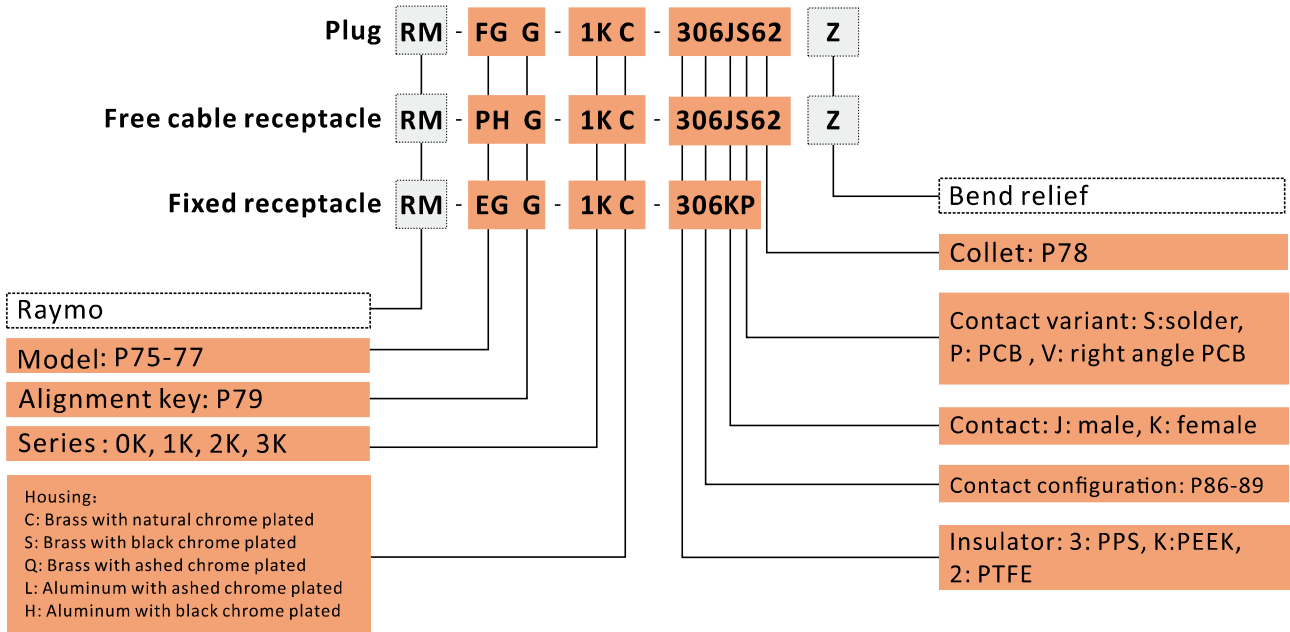

## Part No.Example

### Straight plug with cable collet

RM-FGG-1KC-303JS62Z straight plug with key (G) and cable collet, 1K series, multipole 3 contacts, outer shell in natural chrome-plated brass, PPS insulator, male solder contacts, collet for 5.2-6.2 mm diameter cable, with a black colour bend relief.

### Free cable receptacle

RM-PHG-1KC-303KS62Z free cable receptacle (G) and cable collet, 1K series, multipole 3 contacts, outer shell in natural chrome-plated brass, PPS insulator, female solder contacts, collet for 5.2-6.2 mm diameter cable, with a black colour bend relief.

### Fixed receptacle

RM-EGG-1KC-303KP fixed receptacle, nut fixing, with key (G), 1K series, multipole 3 contacts, outer shell in natural chrome plated brass, PPS insulator, female pcb contacts.

## Part Section Showing Internal Components

### Cable Mount Plug

- ① Outer shell
- ② Male contact
- ③ Latch sleeve
- ④ Insulator
- ⑤ Inner shell
- ⑥ Split insert carrier A/B
- ⑦ Retaining ring
- ⑧ Earthing cone
- ⑨ O-ring
- ⑩ Washer
- ⑪ Cable collet
- ⑫ Collet nut

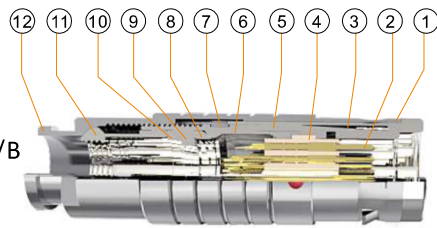

### Fixed Receptacle

- ① Outer shell
- ② Hexagonal nut
- ③ Outer o-ring
- ④ Inner o-ring
- ⑤ Retaining ring
- ⑥ Earthing crown
- ⑦ Insulator
- ⑧ Female contact

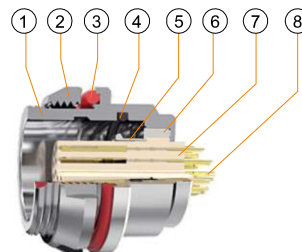

## Technical Characteristics

### Mechanical and Climatical

Characteristics	Value	Standard
Endurance	>5000cycles	IEC60512-5test9a
Humidity	Up to 95% at 60°C	
Temperature range	-55°C, +250°C	
Resistance to vibrations	10-2000Hz, 15g	IEC 60512-4 test 6d
Shock resistance	100g, 6ms	IEC 60512-4 test 6c
Salt spray corrosion test	>96h	IEC 60512-6 test 11f
Protection index (mated)	IP 68	IEC 60529
Climatical category	55/175/21	IEC 60068-1

### Electrical

Characteristics		Value	Standard
Shielding efficiency	at 10 MHZ	>95 dB	IEC 60619-1-3
	at 1 GHZ	>80 dB	IEC 60619-1-3

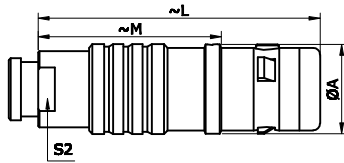

**RM-FGG** Cable Mount Straight Plug,  
nut for fitting a bend relief

Reference		Dimensions(mm)			
Model	Series	A	L	M	S2
RM-FGG	0K	11.0	34.0	23.0	7.0
RM-FGG	1K	13.0	42.0	28.0	9.0
RM-FGG	2K	16.0	52.0	36.0	12.0
RM-FGG	3K	19.0	60.0	40.0	15.0

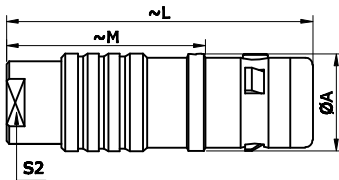

**RM-FGG** Cable Mount Straight Plug

Reference		Dimensions(mm)			
Model	Series	A	L	M	S2
RM-FGG	0K	11.0	34.0	23.0	7.0
RM-FGG	1K	13.0	42.0	28.0	9.0
RM-FGG	2K	16.0	52.0	36.0	12.0
RM-FGG	3K	19.0	60.0	40.0	15.0

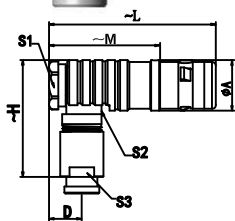
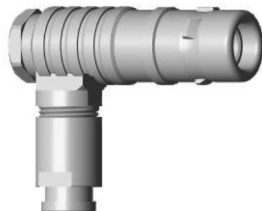

**RM-FPG** Cable Mount Straight Plug

Reference		Dimensions(mm)							
Model	Series	A	D	H	L	M	S1	S2	S3
RM-FPG	0K	11.0	7.3	25.0	36.0	25.0	9.0	8.0	8.0
RM-FPG	1K	13.0	8.7	33.0	42.0	28.0	11.0	9.0	10.0
RM-FPG	2K	16.0	10.2	40.0	51.0	35.0	14.0	12.0	13.0

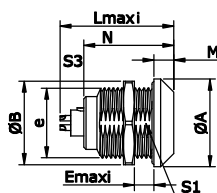

**RM-EGG** Panel Mount Fixed Receptacle

Reference		Dimensions(mm)								
Model	Series	A	B	e	E	L	M	N	S1	S3
RM-EGG	0K	18.0	19.2	M14*1.0	6	21.7	4.0	20.0	12.5	17
RM-EGG	1K	20.0	21.5	M16*1.0	9	27.0	4.5	25.1	14.5	19
RM-EGG	2K	25.0	27.0	M20*1.0	9	30.7	5.0	28.6	18.5	24
RM-EGG	3K	31.0	34.0	M24*1.0	11	36.2	6.0	33.6	22.5	30

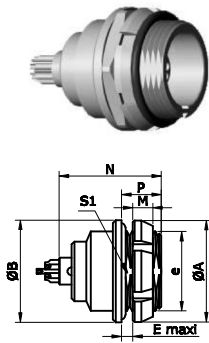

**RM-EEG** Panel Mount Fixed Receptacle, back panel mounting

Reference		Dimensions(mm)							
Model	Series	A	B	e	E	M	N	P	S1
RM-EEG	0K	18.0	18.0	M14*1.0	3.4	3.5	20.1	7.0	12.5
RM-EEG	1K	20.0	20.0	M16*1.0	6.2	3.5	25.1	10.0	14.5
RM-EEG	2K	25.0	25.0	M20*1.0	5.0	3.5	28.6	10.0	18.5
RM-EEG	3K	30.0	31.0	M24*1.0	7.5	4.5	33.6	12.0	22.5

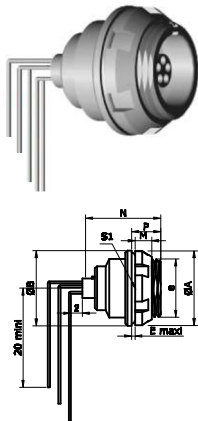

**RM-EEG** Panel Mount Fixed Receptacle elbow 90° contact for printed circuit ( back panel mounting )

Reference		Dimensions(mm)							
Model	Series	A	B	e	E	M	N	P	S1
RM-EEG	0K	18.0	18.0	M14*1.0	3.4	3.5	20.1	7.0	12.5
RM-EEG	1K	20.0	20.0	M16*1.0	6.2	3.5	25.1	10.0	14.5
RM-EEG	2K	25.0	25.0	M20*1.0	5.0	3.5	28.6	10.0	18.5
RM-EEG	3K	30.0	31.0	M24*1.0	7.5	4.5	33.6	12.0	22.5

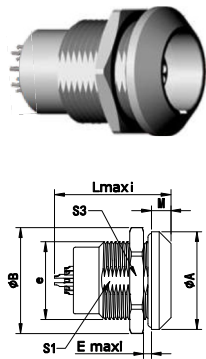

**RM-HGG** Panel Mount Fixed Receptacle, Watertight or vacumtight

Reference		Dimensions(mm)							
Model	Series	A	B	e	E	L	M	S1	S3
RM-HGG	0K	18.0	19.2	M14*1.0	5.5	21.7	4.0	12.5	17.0
RM-HGG	1K	20.0	21.5	M16*1.0	9.0	30.0	4.5	14.5	19.0
RM-HGG	2K	25.0	27.0	M20*1.0	13.0	33.7	5.0	18.5	24.0
RM-HGG	3K	31.0	34.0	M24*1.0	16.0	41.7	6.0	22.5	30.0

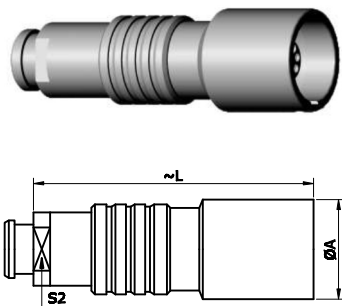

**RM-PHG** Cable Mounted Receptacles, nut for fitting a bend relief

Reference		Dimensions(mm)		
Model	Series	A	L	S2
RM-PHG	0K	13.0	34.0	7.0
RM-PHG	1K	15.0	45.0	9.0
RM-PHG	2K	19.0	54.0	12.0
RM-PHG	3K	23.0	64.0	15.0

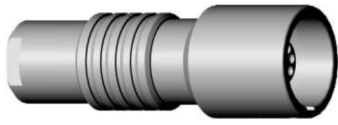

### RM-PHG Cable Mounted Receptacles

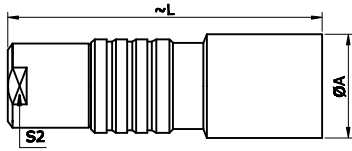

Reference		Dimensions(mm)		
Model	Series	A	L	S2
RM-PHG	0K	13.0	34.0	8.0
RM-PHG	1K	15.0	45.0	9.0
RM-PHG	2K	19.0	54.0	12.0
RM-PHG	3K	23.0	65.0	15.0

## RM-K series Cable collet

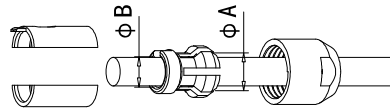

Cable Clamp Set		Cable collet (mm)	Cable dia Range	
type	code	φA	Max	Min
RM-CCT-0K-021	21	2.1	2.2	1.4
RM-CCT-0K-032	32	3.2	3.2	>2.2
RM-CCT-0K-042	42	4.2	4.2	>3.2
RM-CCT-0K-052	52	5.2	5.2	>4.2

Cable Clamp Set		Cable collet (mm)	Cable dia Range	
type	code	φA	Max	Min
RM-CCT-1K-042	42	4.2	4.2	2.5
RM-CCT-1K-052	52	5.2	5.2	>4.2
RM-CCT-1K-062	62	6.2	6.2	>5.2
RM-CCT-1K-072	72	7.2	7.2	>6.2
RM-CCT-1K-076	76	7.6	7.5	7.1 ①

Cable Clamp Set		Cable collet (mm)	Cable dia Range	
type	code	φA	Max	Min
RM-CCT-2K-042	42	4.2	4.2	>3.2
RM-CCT-2K-052	52	5.2	5.2	>4.2
RM-CCT-2K-062	62	6.2	6.2	>5.2
RM-CCT-2K-072	72	7.2	7.2	>6.2
RM-CCT-2K-082	82	8.2	8.2	>7.2
RM-CCT-2K-092	92	9.2	9.2	>8.2
RM-CCT-2K-099	99	9.9	9.7	9.1 ①

Cable Clamp Set		Cable collet (mm)	Cable dia Range	
type	code	φA	Max	Min
RM-CCT-3K-062	62	6.2	6.2	4.9
RM-CCT-3K-072	72	7.2	7.7	>6.2
RM-CCT-3K-082	82	8.2	8.0	7.1
RM-CCT-3K-092	92	9.2	9.2	>7.7
RM-CCT-3K-100	10	10.2	10.7	>9.2
RM-CCT-3K-110	11	11.2	11.0	10.1
RM-CCT-3K-120	12	11.9	11.7	11.1 ①

① This cable collet is only for crimping type cable collet, not fit for cable nut with bend relief type.



## Alignment key and Polarized Keys( RM-K series)

RM-K series connector model type are composed of five letters.





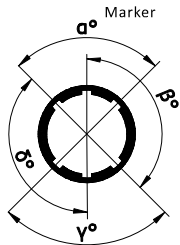





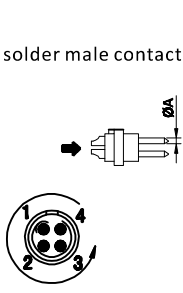
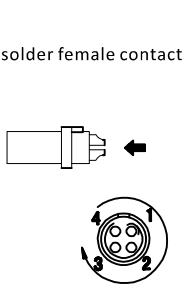

















The LAST LETTER indicates the key position and the contact type ( male or female).

Front view of receptacle



Code	Keys No.	Angles	Series				Contact Type	
			0K	1K	2K	3K	Plug	Receptacle
G	1		0°	0°	0°	0°	Male	Female
A	2	α	30°	30°	30°	30°	Male	Female
B	2		45°	45°	45°	45°	Male	Female
C	2		60°	60°	60°	60°	Male	Female
D	2	γ	95°	95°	95°	95°	Male	Female
E	2	β	120°	120°	120°	120°	Male	Female
F	2		145°	145°	145°	145°	Male	Female
L	2	γ	75°	75°	75°	75°	Female	Male

### Insulator Configuration

	 		Insulator	Contact No.	φ A (MM)	Contact type			Test voltage(contact -contact)k/v rms	Test voltage(contact -shell)k/v rms	Rated current /A
	Solder contact	PCB straight contact				PCB elbow contact					
00B			302	2	0.5	●	●	●	1.00	0.95	5.0
			303	3	0.5	●	●	●	0.80	0.95	3.0
			304	4	0.5	●	●	●	0.80	0.65	2.0
0L 0B 0K 0W			302	2	0.9	●	●	●	1.30	1.05	10.0
			303	3	0.9	●	●	●	1.20	0.90	8.0
			304	4	0.7	●	●	●	0.85	0.70	7.0
			305	5	0.7	●	●	●	1.00	0.70	6.5
			306	6	0.5	●	●	●	0.85	0.65	2.5
			307	7	0.5	●	●	●	0.80	0.70	2.5
			309	9	0.5	●	●	○	0.60	0.50	2.0
1L 1B 1K 1W			302	2	1.3	●	●	●	1.50	1.35	15.0
			303	3	1.3	●	●	●	1.30	1.55	12.0
			304	4	0.9	●	●	●	1.35	1.45	10.0
			305	5	0.9	●	●	●	1.25	1.15	9.0





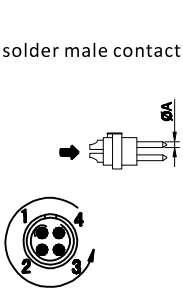
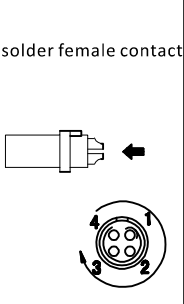
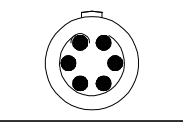
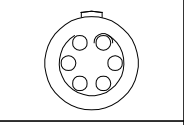
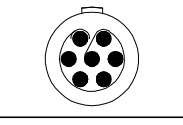
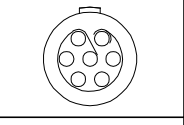
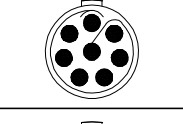
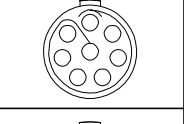
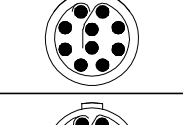
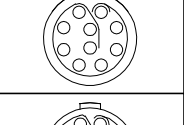
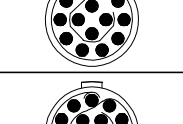
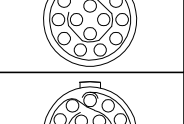
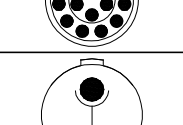
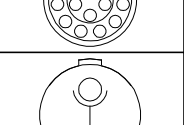
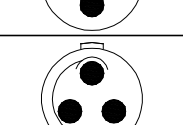
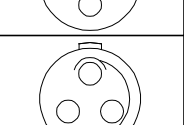
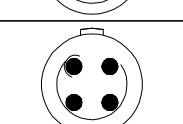
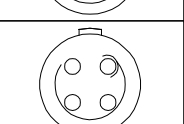
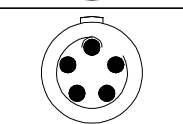
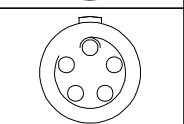
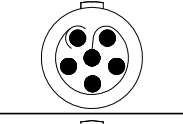
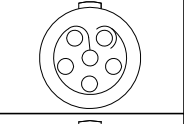
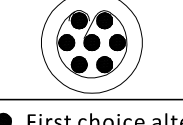
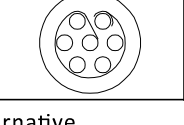
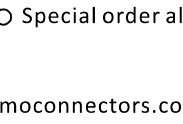
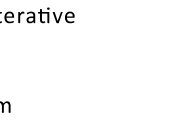

- First choice alternative
- Special order alternative

### Insulator Configuration

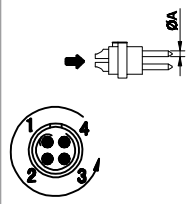
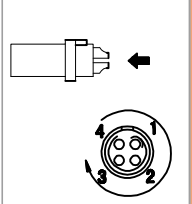
	solder male contact 	solder female contact 	Insulator	Contact No.	$\phi$ A (MM)	Contact type			Test voltage(contact -contact)k/v rms	Test voltage(contact -shell)k/v rms	Rated current/A
						Solder contact	PCB straight contact	PCB elbow contact			
1L 1B 1K 1W			306	6	0.7	●	●	●	1.05	1.20	7.0
			307	7	0.7	●	●	●	0.95	1.05	7.0
			308	8	0.7	●	●	●	0.95	1.15	5.0
			310	10	0.5	●	●	●	0.90	1.50	2.5
			314	14	0.5	●	●	●	0.80	1.20	2.0
			316	16	0.5	●	●	○	0.80	1.25	1.5
2B 2K 2W			302	2	2.0	●	●	●	2.10	1.75	25.0
			303	3	1.6	●	●	●	2.40	1.85	17.0
			304	4	1.3	●	●	●	1.85	1.85	15.0
			305	5	1.3	●	●	●	1.75	1.60	14.0
			306	6	1.3	●	●	●	1.35	1.45	12.0
			307	7	1.3	●	●	●	1.35	1.45	11.0

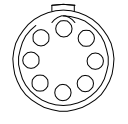

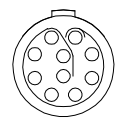
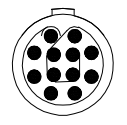
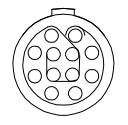
- First choice alternative
- Special order alternative

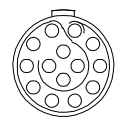
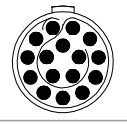
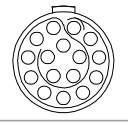
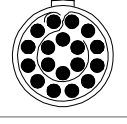
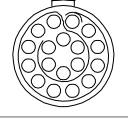
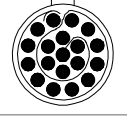
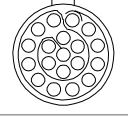
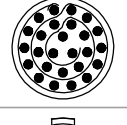
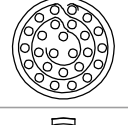
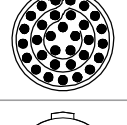
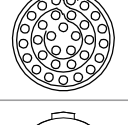
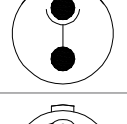
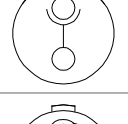
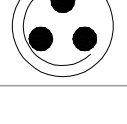
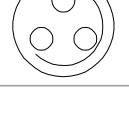
## Insulator Configuration

	solder male contact	solder female contact	Insulator	Contact No.	$\phi$ A (MM)	Contact type			Test voltage(contact -contact)k/v rms	Test voltage(contact -shell)k/v rms	Rated current /A
						Solder contact	PCB straight contact	PCB elbow contact			
<b>2B 2K 2W</b>			308	8	0.9	●	●	●	1.50	1.25	10.0
			310	10	0.9	●	●	●	1.45	1.30	8.0
			312	12	0.7	●	●	●	1.25	1.35	7.0
			314	14	0.7	●	●	●	1.15	1.35	6.5
			316	16	0.7	●	●	●	0.95	1.25	6.0
			318	18	0.7	●	●	●	0.85	1.20	5.5
			319	19	0.7	●	●	●	0.95	1.25	5.0
			326	26	0.5	●	●	○	0.95	1.30	2.0
			332	32	0.5	●	●	○	0.80	1.20	1.5
<b>3B 3K</b>			302	2	3.0	●	○	-	2.10	1.55	35.0
			303	3	2.0	●	●	○	1.90	1.50	25.0

- First choice alternative
- Special order alternative

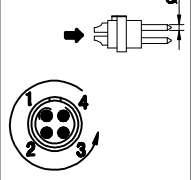
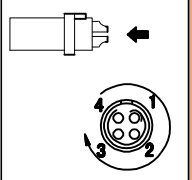
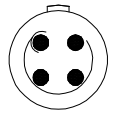
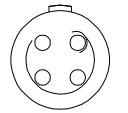
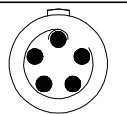
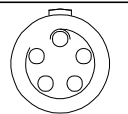
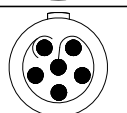
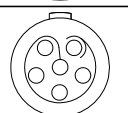
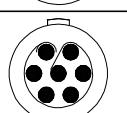
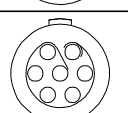
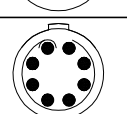
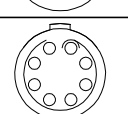
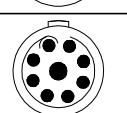
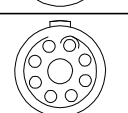
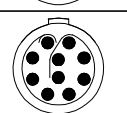
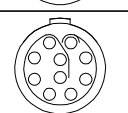
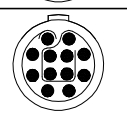
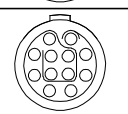
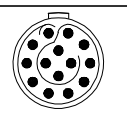
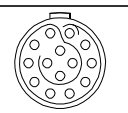
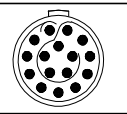
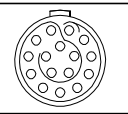
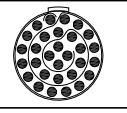
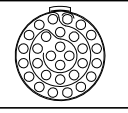
## Insulator Configuration

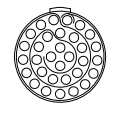
		solder male contact		solder female contact		Contact type			Test voltage(contact -contact)k/v rms	Test voltage(contact -shell)k/v rms	Rated current /A
						Solder contact	PCB straight contact	PCB elbow contact			
3B 3K			304	4	2.0	●	●	●	1.45	1.25	19.0
			305	5	1.6	●	●	○	1.90	1.25	19.0
			306	6	1.6	●	●	○	1.60	1.15	17.0
			307	7	1.6	●	●	○	1.70	1.25	15.0
			308	8	1.3	●	●	●	1.65	1.15	13.0
			309	8 1	1.3 2.0	●	●	-	1.35 1.35	1.05 1.05	6.0 15.0
			310	10	1.3	●	●	○	1.25	0.90	12.0
			312	12	0.9	●	●	●	1.45	1.00	9.0
			314	14	0.9	●	●	●	1.20	1.20	9.0
			316	16	0.9	●	●	●	1.20	0.85	8.0
			330	30	0.7	●	●	●	0.8	0.7	3.5
			332	32	0.7	●	●	●	0.75	0.7	3.0

- First choice alternative
- Special order alternative