

MAIN FEATURES

HIGH PERFORMANCE

- > Standard resolution 16 or 32 detent
- > With or without integrated push button
- > Rotational life: Up to 1,000,000 revolutions
- > No detent up to 4.5 Ncm switching torque (remains consistent over lifetime)
- > Gold plated contacts
- > Robust metal housing with metal shaft
- > Body size 11.5 x 12.3 x 4.9 mm
- > Optional front panel sealing IP68
- > Operating temperature range: -40 to +85°C
- > Shaft electrically insulated > 500 VDC (shaft to contact system)
- > Various options and customizations

SWISS CLICK INDEXING SYSTEM™

MIL-STD-202G compliant

TYPE E33



For information about the SWISS CLICK INDEXING SYSTEM™ see chapter technical explanations

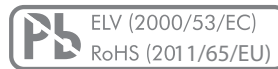

PRODUCT VARIETY

- Vertical or horizontal mounting
- THT or SMT reflow (vacuum pick & place)
- Threaded or non-threaded bushing
- Push button force 3, 6, 10, 14 N or without push button
- Detent/pulses per rev. (PPR) 32/16, 32/8, 16/16, 16/8
- Switching torque 0.5, 1.0, 1.5, 2.0, 2.5, 3.0, 3.5 or 4.5 Ncm or no detent
- Front panel sealing IP60 or ² IP68
- Shaft mounted, separated or without shaft
- Various standard shafts available
- Tray or tape & reel packaging

TYPICAL APPLICATIONS

- Value and menu control for industrial PLCs
- Avionics, instrumentation, test equipment
- Frequency and channel selection for two way radios
- User interface controls for medical devices
- Volume and menu setting for transportation control and entertainment systems

POSSIBLE CUSTOMIZATIONS

- Shaft dimension and shape
- Stainless steel housing
- Switching torque and push button actuation force
- Indexing resolution and PPR

1 PREFERENCE TYPES SELECTION CHART

¹ For other types/options, see type key.
² Non-threaded bushing: gasket provides IP65.
³ Nut supplied.

THREADED BUSHING, IP68

PUSH BUTTON	IP SEALING	RESOLUTION	TORQUE	PART NUMBER THT VERTICAL (³ THREADED BUSHING)	PART NUMBER SMT VERTICAL (NON-THREADED BUSHING)
Yes, 6 N	IP60	32 detent (16 PPR)	2.0 Ncm	E33-VT610-M01T	E33-SN610-M01T
		16 detent (8 PPR)	2.5 Ncm	E33-VT630-M01T	E33-SN630-M01T
	² IP68 (Shaft & front panel)	32 detent (16 PPR)	2.0 Ncm	E33-VT612-M01T	E33-SN612-M01T
		16 detent (8 PPR)	2.5 Ncm	E33-VT632-M01T	E33-SN632-M01T
No	IP60	32 detent (16 PPR)	2.0 Ncm	E33-VT010-M01T	E33-SN010-M01T
		16 detent (8 PPR)	2.5 Ncm	E33-VT030-M01T	E33-SN030-M01T
	² IP68 (Shaft & front panel)	32 detent (16 PPR)	2.0 Ncm	E33-VT012-M01T	E33-SN012-M01T
		16 detent (8 PPR)	2.5 Ncm	E33-VT032-M01T	E33-SN032-M01T

All these types are tray packed and fitted with standard shaft type 01.

SPECIFICATIONS

MECHANICAL DATA

Resolution:	32, 16 or no detent
¹ Switching torque (new condition):	For 32 detent: 0.5, 1.0, 1.5, 2.0 or 3.0 Ncm (+/- 30%) For 16 detent: 0.5, 1.5, 2.5, 3.5 or 4.5 Ncm (+/- 30%)
² Rotational life:	1'000'000 revolutions min. with 0.5, 1.0 or 1.5 Ncm switching torque or without detent 500'000 revolutions min. with 2.0 Ncm switching torque 300'000 revolutions min. with 2.5 Ncm switching torque 100'000 revolutions min. with 3.0, 3.5 or 4.5 Ncm switching torque
Residual switching torque (end of life):	90% typ.
Shaft strength:	100 N min. push, 100 N min. pull, 50 N min. bending (snap-in shaft mechanism)
Fastening torque of nut (front panel mounting):	100 Ncm max.

ELECTRICAL DATA

Coding/output:	2-bit quadrature
Resolution:	16 or 8 pulses per revolution (PPR) per channel
Phase shift (A leads B clockwise):	90° (+/- 70°)
Pulse width per channel:	180° (+/- 36°)
Operating speed:	60 RPM max.
Load current:	10 mA max. (resistive load, 15 VDC max. voltage)
Contact bouncing time:	2 ms max.
Contact resistance:	10 Ω max. (over the entire rotational life)
Insulation resistance:	1GΩ min 500 VDC
Breakdown voltage:	e.g. 500 VAC min. between insulated parts at standard atmospheric pressure.
Dielectric withstanding voltage to housing/shaft:	500 VDC during 60 seconds (MIL-STD-202G, method 301)

MATERIAL DATA

Shaft:	Brass (CuZn38Pb2) or stainless steel (1.4305); see shaft catalog in type key
Housing:	Zinc diecast with glossy nickel plating, fiber enforced high performance plastic
Nut:	Brass with glossy nickel plating
Contact system:	Alloy copper, AuCo plated (hard gold)
Soldering leads:	Alloy copper, tin plated
Housing clamp, retention clips:	Tinplate, tin plated
O-rings:	NBR (nitrile), 70 shore, reflowable
Gasket (non-threaded bushing):	Closed-cell EPDM based rubber, 45 shore A, complies with SAE J 18-79, reflowable

ENVIRONMENTAL DATA

² Operating temperature range:	-40 to +85°C (IEC 60068-2-14)
Storage temperature range:	-65 to +125°C (IEC 60068-2-14, MIL-STD202G, method 107G, condition B-3)
Humidity (non condensing):	93% RH max. (MIL-STD-202G, method 103B, condition B)
IP sealing:	IP60, optional IP68 (2 bar, 1 h) shaft/front panel sealing (non-threaded bushing; gasket provides IP65)
Vibration:	29 G _{rms} max. @ 100 to 1000 Hz (MIL-STD-202G, method 214A, condition 1H/15 minutes)
Shock:	100 G max. (MIL-STD-202G, method 213B, condition C)
Flammability:	UL94-V0 (IP65/IP68: O-rings and non-threaded bushing gasket are UL94-HB)

PACKAGING QUANTITY

Tray:	10 or 50 pcs., depending on shipping qty. (nuts are supplied and packed separately)
Tape & reel:	200 pcs. (SMT only, with vacuum plug, shafts/nuts are supplied and packed separately)

¹ O-ring of IP65/IP68 shaft sealing may slightly increase switching torque.

² Rotational/actuation life is tested at room condition (+25°C, 50 to 60% RH). Operating speed is 60 RPM (encoder) and 2 Hz (push button). Different operating conditions may decrease life expectation dramatically.

SPECIFICATIONS

ADDITIONAL DATA FOR PUSH BUTTON SWITCH: MECHANICAL DATA

Push button actuation force (new condition):	3, 6, 10, 14 N (+/- 30%) or without push button force
Push button switch travel:	0.5 (+/- 0.2) mm
² Push button switch life:	200'000 actuations min.
Residual push button actuation force (end of life):	90% typ.

ADDITIONAL DATA FOR PUSH BUTTON SWITCH: ELECTRICAL DATA

Load current:	10 mA max. (resistive load, 15 VDC max. voltage)
Contact bouncing time:	2 ms max.
Dielectric withstanding voltage to housing/shaft:	500 VDC during 60 seconds (MIL-STD-202G, method 301)

ADDITIONAL DATA FOR PUSH BUTTON SWITCH: MATERIAL DATA

Contact pads:	Alloy copper, AuCo plated (hard gold)
Membrane switch:	Stainless steel, AuCo plated (hard gold)

SOLDERING CONDITIONS

Hand soldering:	300°C max. during 3 sec max.
Wave soldering:	280°C max. peak temperature during 5 sec max.

REFLOW PROFILE (COMPLIES WITH IPC/JEDEC J-STD-020C)

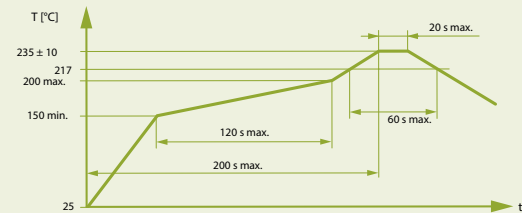

Temperatures or process durations exceeding rated maximum conditions may harm encoder function

RECOMMENDED SYSTEM INTERFACE

Timing diagram shows 32/16 (16/8) detents/PPR resolution

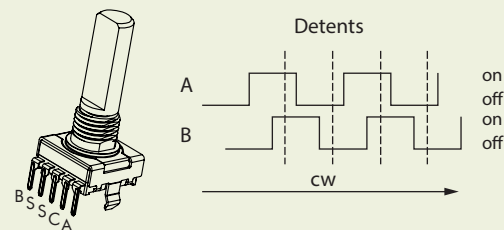

Connection diagram (Example)

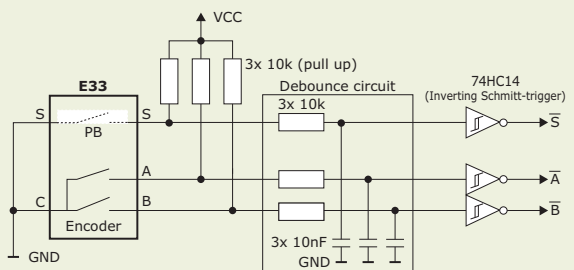

² Rotational/actuation life is tested at room condition (+25°C, 50 to 60% RH). Operating speed is 60 RPM (encoder) and 2 Hz (push button). Different operating conditions may decrease life expectation dramatically.

DRAWINGS

Tolerances unless otherwise specified DIN ISO 2768-1 (m)

THT VERTICAL

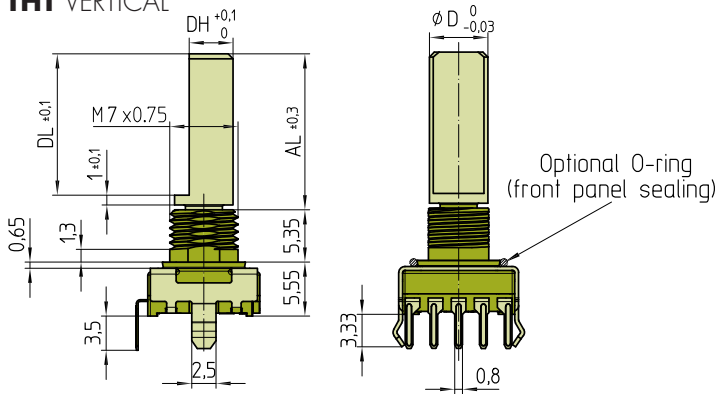

DRILLING DIAGRAM

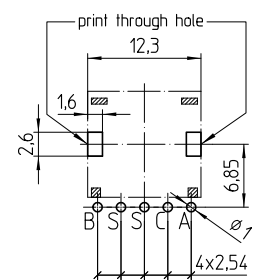

PCB-thickness: 1 to 1.5mm
View from component side of the PCB

THT HORIZONTAL

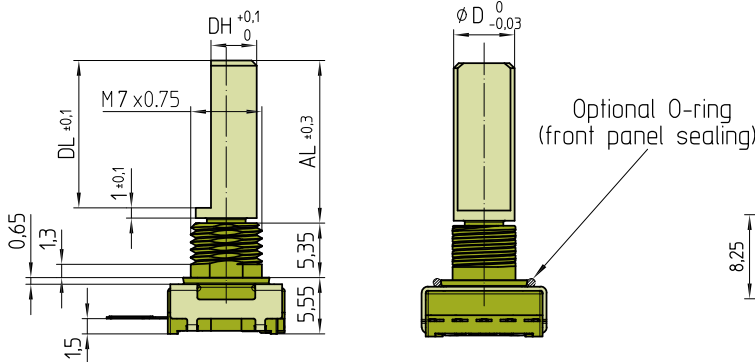

DRILLING DIAGRAM

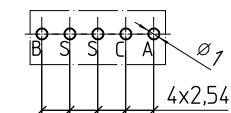

PCB-thickness: 1 to 1.5mm
View from component side of the PCB

SMT VERTICAL

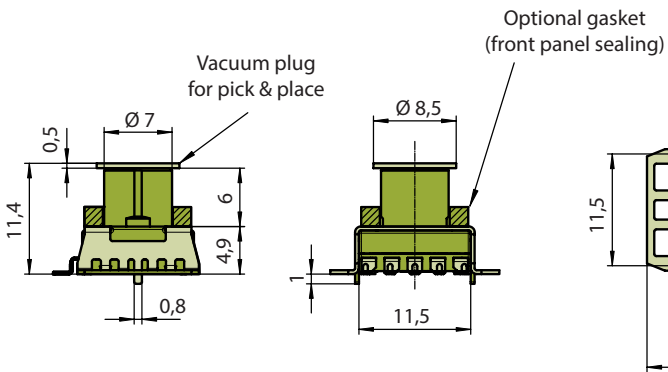

DRILLING DIAGRAM

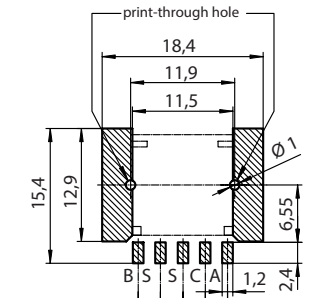

View from component side of the PCB

NUT

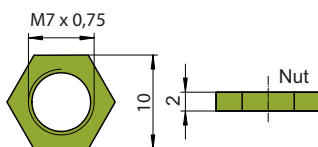

Spare part
Part Number (50 pcs. bag)
- Brass nickel plated: 4516-40

FRONT PANEL CUT OUT

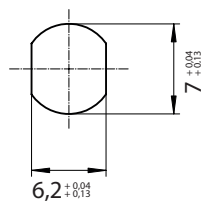

TAPE & REEL PACKAGING

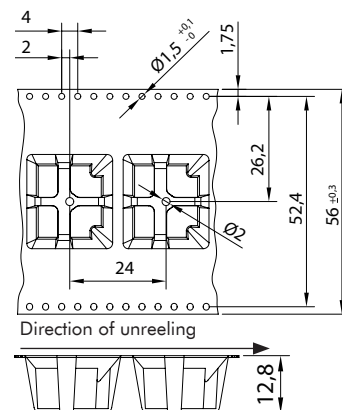

Reel size: 13"
200 pcs. per reel
Tape width: 56 mm
Tape pitch: 24 mm

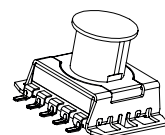

All shaft and bushing types are available for all versions, THT vertical, THT horizontal or SMT vertical (see type key).

ENCODER TYPE E33

TYPE KEY

E 33	-	-	-	-	-	-	-	-	-	-	-
-------------	---	---	---	---	---	---	---	---	---	---	---

ORIENTATION/MOUNTING

- V** THT vertical
- C** THT horizontal
- S** SMT vertical

BUSHING

- T** Threaded M7 x 0.75 x 6 mm (nut supplied, packed separately)
- N** Non-threaded Ø 7 x 6 mm

PUSH BUTTON

- 6** 6 N
- 3** 3 N
- 0** Without push button
- ³**A** 10 N
- ³**E** 14 N

³ Available beginning 2015

RESOLUTION, ¹ TORQUE

1	32 detent	(16 PPR)	2.0 Ncm
2	16 detent	(8 PPR)	1.5 Ncm
3	16 detent	(8 PPR)	2.5 Ncm
4	32 detent	(8 PPR)	2.0 Ncm
5	16 detent	(16 PPR)	1.5 Ncm
6	16 detent	(16 PPR)	2.5 Ncm
8	No detent	(16 PPR)	
9	No detent	(8 PPR)	
A	32 detent	(16 PPR)	0.5 Ncm
B	32 detent	(16 PPR)	1.0 Ncm
² C	32 detent	(16 PPR)	1.5 Ncm
² D	32 detent	(16 PPR)	3.0 Ncm
² E	16 detent	(8 PPR)	0.5 Ncm
² F	16 detent	(8 PPR)	3.5 Ncm
G	16 detent	(8 PPR)	4.5 Ncm

¹ O-ring of IP65/IP68 shaft sealing may slightly increase switching torque.
² Available beginning 2015

PACKAGING

- T** Tray (THT or SMT, 10 or 50 pcs. tray size, depending on shipping qty.)
- R** Tape & reel with vacuum plug (SMT only, 200 pcs. per reel, shafts separated)

SHAFT TYPE

For all available shaft types please see next page

SHAFT SEPARATION

- M** Mounted
- S** Separated (snap-in shaft mechanism)
- N** No shaft

IP SEALING

- 0** IP60
- ¹**1** IP68 shaft sealing
- ¹**2** IP68 shaft/front panel sealing (non-threaded bushing gasket provides IP65, O-ring/gasket is mounted)

¹ O-ring of IP65/IP68 shaft sealing may slightly increase switching torque.

O-RING MOUNTING TOOL



Part Number: E33-ORING-TOOL

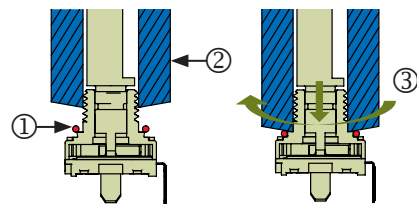

- ① Slip the lubricated O-ring over the bushing.
- ② Slide the mounting tool over the bushing.
- ③ While pushing down the O-ring simultaneously rotate the mounting tool.

SHAFT TYPES FOR E33 TYPE KEY

Tolerances unless otherwise specified DIN ISO 2768-1 (m)

TYPE 00 - NO SHAFT

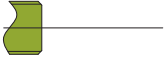

TYPE 01 - BRASS

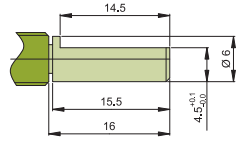

TYPE 03 - BRASS

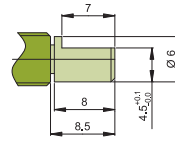

TYPE 30 - BRASS

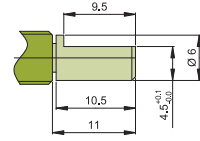

TYPE 31 - STAINLESS STEEL

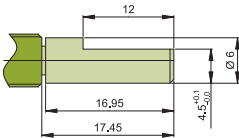

TYPE 32 - BRASS

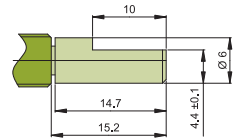

TYPE 33 - STAINLESS STEEL

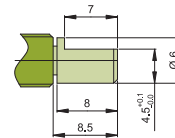

TYPE 34 - BRASS

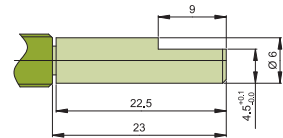

TYPE 37 - STAINLESS STEEL

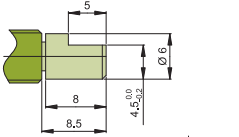

TYPE 70 - BRASS

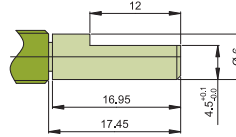

TYPE 71 - BRASS

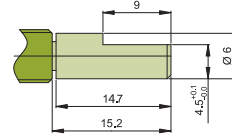

TYPE 72 - BRASS

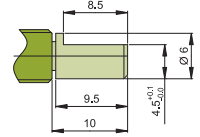

³TYPE 51 - BRASS (Ø 5.35mm)

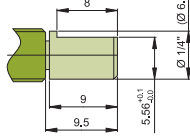

TYPE 10 - BRASS

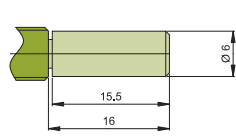

TYPE 11 - BRASS

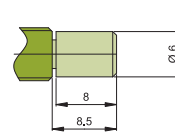

TYPE 12 - BRASS

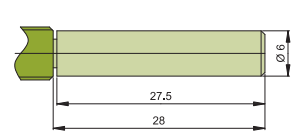

TYPE 13 - STAINLESS STEEL

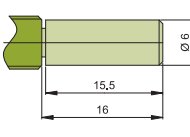

TYPE 14 - STAINLESS STEEL

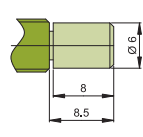

TYPE 15 - BRASS

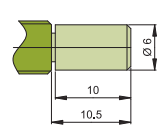

TYPE 16 - BRASS

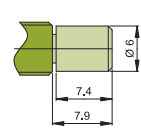

³TYPE 20 - BRASS (Ø 5.35mm)

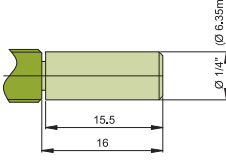

TYPE 02 - BRASS

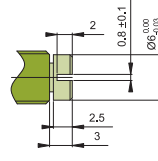

TYPE 43 - BRASS

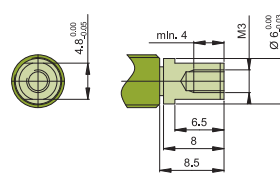

TYPE 42 - BRASS

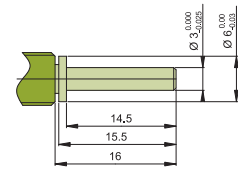

TYPE 45 - STAINLESS STEEL

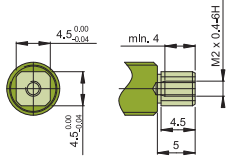

TYPE 47 - BRASS

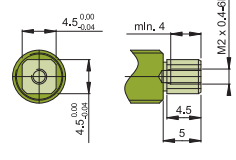

TYPE 08 - BRASS

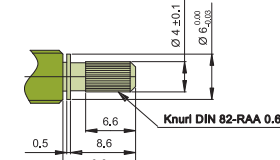

TYPE 40 - BRASS

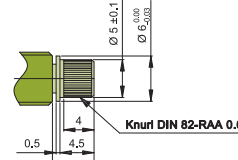

TYPE 41 - BRASS

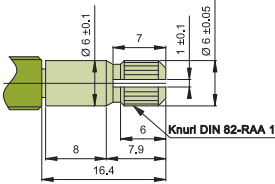

TYPE 60 - BRASS

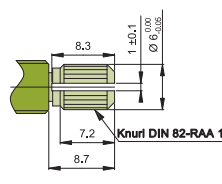

TYPE 0H - BRASS

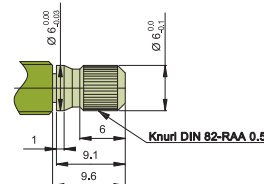

TYPE 44 - BRASS

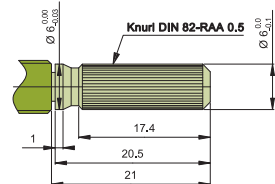

³ Threaded bushing: Shaft to be ordered separately; shaft mounting after encoder assembly to front panel (nut does not fit over 1/4" shaft diameter).

OTHER SHAFTS ARE AVAILABLE ON REQUEST.