



## SPECIFICATIONS

**RATING** : Ith 5A/250VAC resistive load 3A/250VAC  
**CONTACT RESISTANCE** : 50 mΩ max. @ 1A 12VDC (initial value)  
**INSULATION RESISTANCE** : 1,000 MΩ min. at 500VDC  
**DIELECTRIC STRENGTH** : 2,000V RMS @ sea level  
**OPERATION TEMPERATURE** : -20°C to 55°C  
**MECHANICAL LIFE** : Momentary 1,000,000 cycles  
 Self-lock 500,000 cycles  
**ELECTRICAL LIFE** : 50,000 make-and-break cycles at full load  
**TORQUE** : 5~14Nm  
**PANEL THICKNESS** : 10mm (Ø19.20mm)  
**OPERATION PRESSURE** : 1Pole 2.5±1N / 2Poles 3.5±1N  
**TRAVEL** : About 3.2mm  
**INGRESS PROTECTION** : IP67, IK10(Stainless)

## MATERIALS

**BUSHING** : Stainless Steel / Nickel plated brass  
 / Aluminum alloy  
**BASE** : PBT(UL 94-V0) , PC(UL 94-V2)  
**ACTUATOR** : PC(UL 94-V2) ; Stainless Steel  
 / Nickel plated brass / Aluminum alloy  
**INNER ASSEMBLY** : POM / PA66.  
**SPRING** : Spring steel.  
**SEALING** : Silicone.  
**O-Ring** : Silicone.  
**TERMINAL** : Brass,with silver or gold plated.  
**CONTACT** :  
 Q=Copper ,Silver plated.  
 R=Brass,Coin silver,Gold plated  
**HEX NUT** : Nickel plated brass.

## HOW TO ORDER



MODEL NO. BODY TYPE BUTTON TYPE CONTACT CONFIGURATION OPERATING TYPE LIGHT TYPE LED COLOR LED VOLTAGE TERMINAL SHAPE TERMINAL PLATING

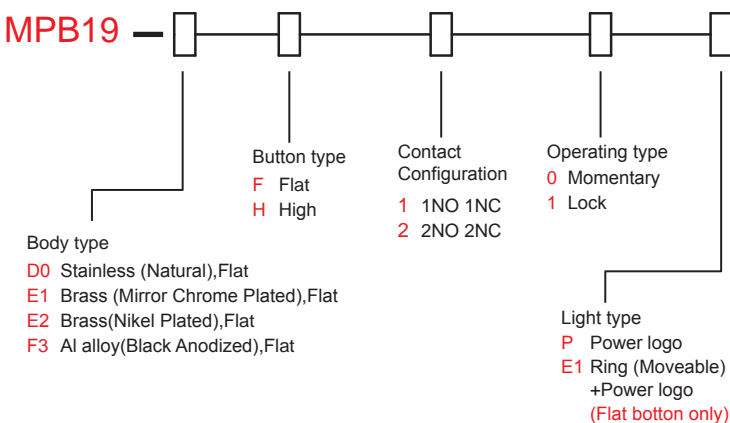
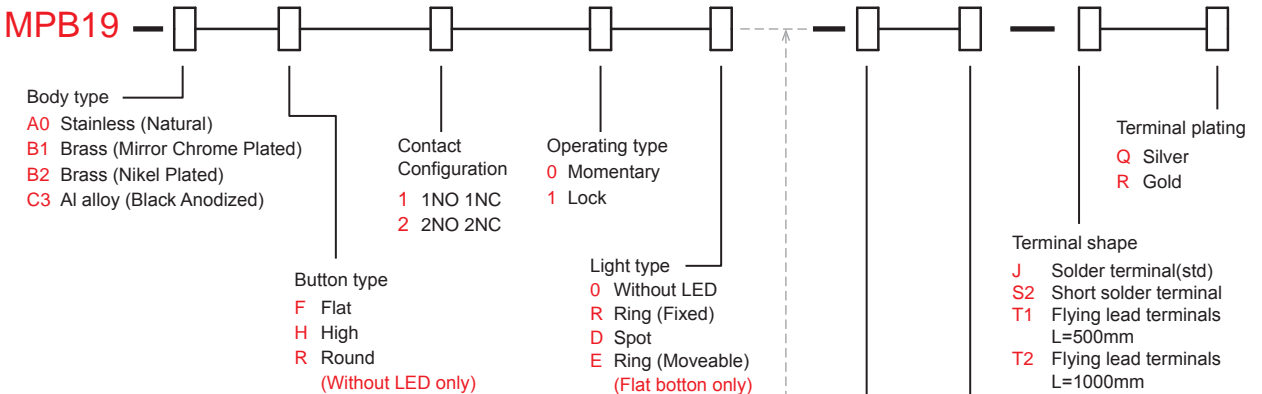

LED Color	
ITEM NO	COLOR
0	Without LED
1	White
3	Red
5	Yellow
6	Green
7	Blue
DUAL COLOR LED	
A	Red&Green
B	Red&Blue
D	Blue&Yellow
G	Red&Yellow
H	Green&Yellow
J	Orange&Green

LED Voltage (20mA)	
ITEM NO	VOLTAGE
0	Without Resistor
3	3V
6	6V
12	12V
24	24V
36	36V
110	110V
220	220V

EXAMPLE:  
 MPB19-A0F100-JQ (Without LED)  
 MPB19-A0F10R- [ ] - [ ] - [ ] - [ ] - [ ] - [ ] - [ ] - [ ] - [ ]  
 LED color — LED voltage

MPB19 Pushbutton Switches

# MPB19 Series

19mm Metal Pushbutton Switches

## CIRCUIT

POSITION 1

POSITION 2



Without LED (1 Pole)

POSITION 1

POSITION 2

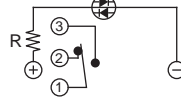
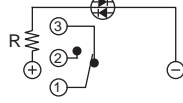

Single Color Led (1 Pole)

POSITION 1

POSITION 2

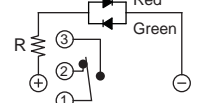
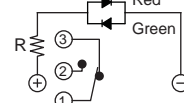

Dual Color Led (1 Pole)

POSITION 1

POSITION 2

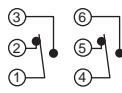
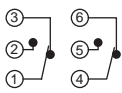

Without LED (2 Poles)

POSITION 1

POSITION 2

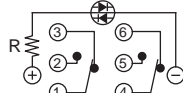

Single Color Led (2 Poles)

POSITION 1

POSITION 2

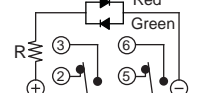
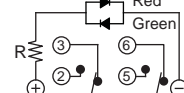

Dual Color Led (2 Poles)

## BODY TYPE

A0/B1/B2/C3 Body

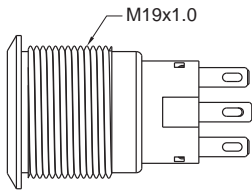

D0/E1/E2/F3 Body (Flat)

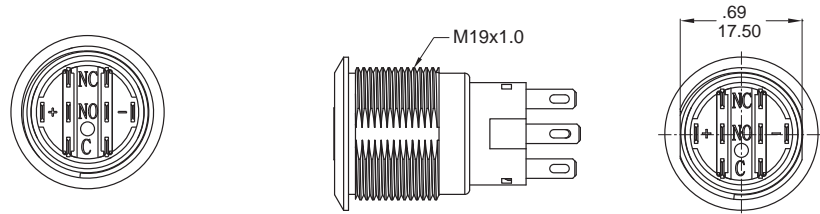

## BUTTON TYPE

F Flat Button

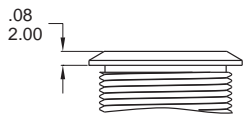

H High Button

\* Ring (Moveable) light type is inapplicable

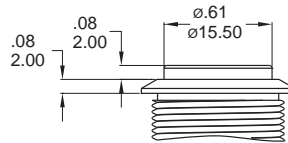

R Round Button

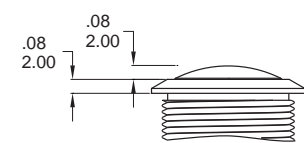

## LIGHT TYPE

O Without LED

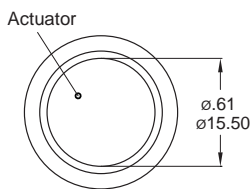

R Ring (Fixed)

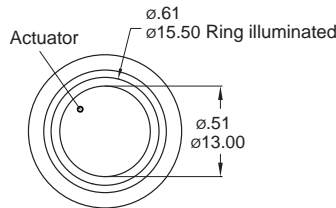

D Spot

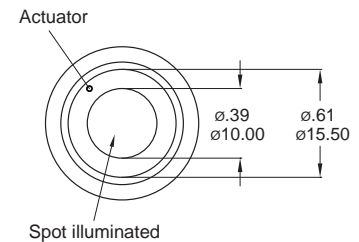

E Ring (Moveable)

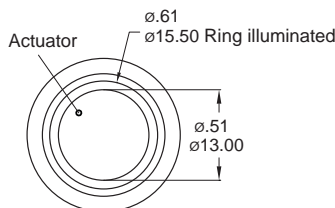

P Power logo

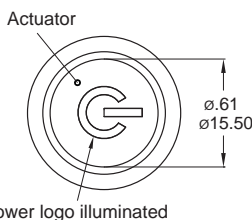

Power logo illuminated

E1 Ring (Moveable)+Power logo

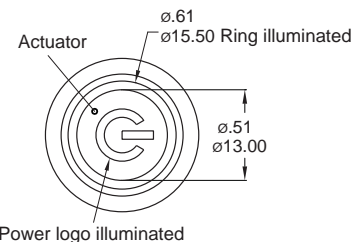

Power logo illuminated

\* Only for A0,B1,B2,C3 body.

\* Only for D0,E1,E2,F3 body.

\* E1 light type only for D0,E1,E2,F3 body.

**FLAT BUTTON TYPE**

**0** Without LED

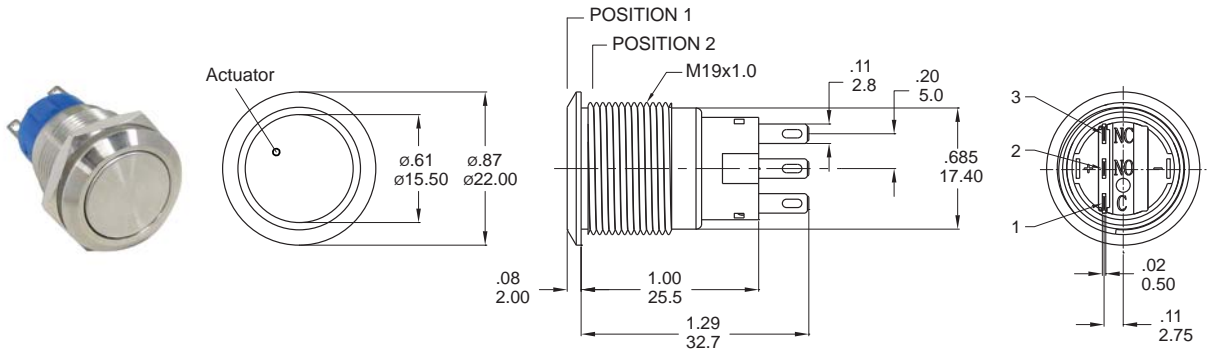

Part No. Shown : MPB19-A0F1□□0-JQ

**R** Ring (Fixed)

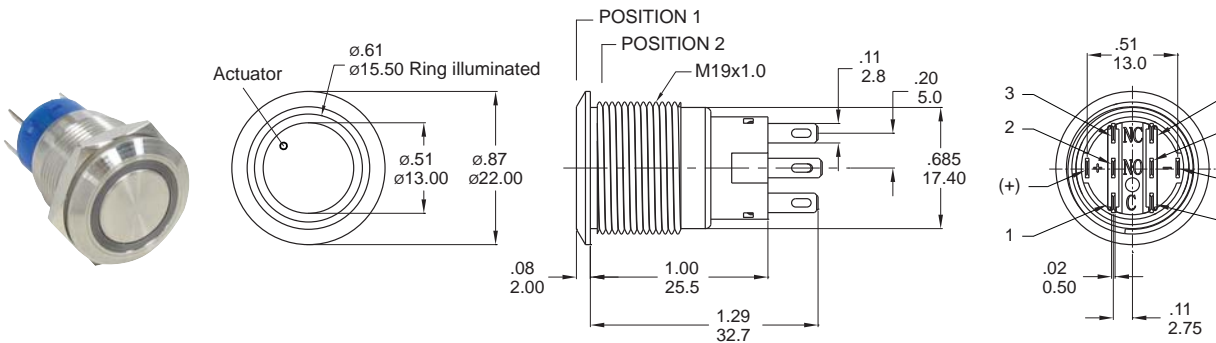

Part No. Shown : MPB19-A0F2□□R-□□-JQ

**D** Spot

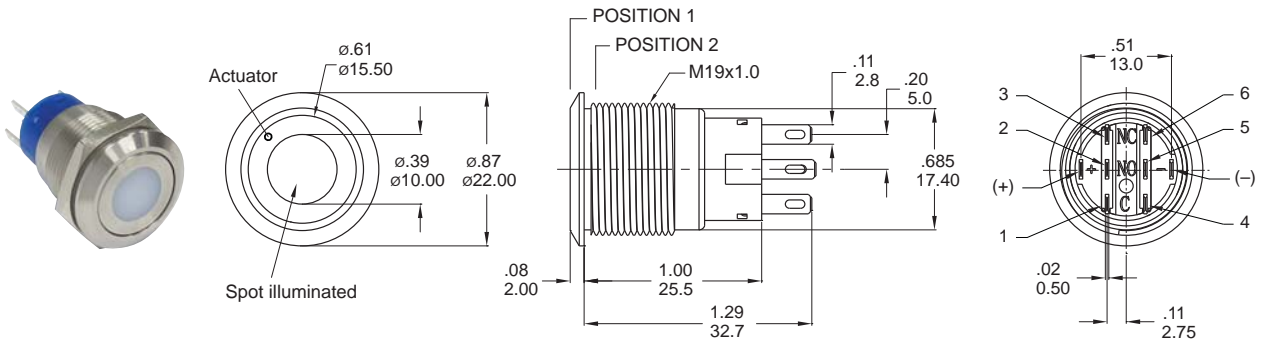

Part No. Shown : MPB19-A0F2□□D-□□-JQ

**E1** Ring (Moveable)+Power logo  
(Flat Button only)

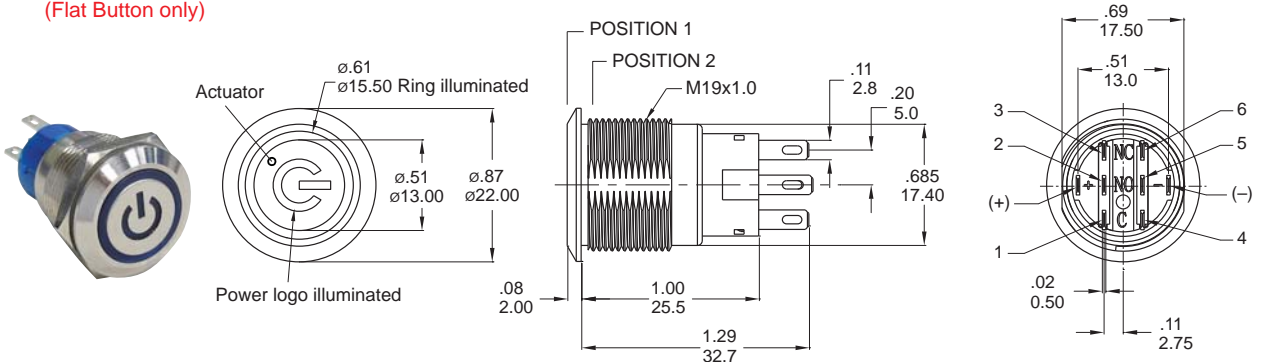

Part No. Shown : MPB19-D0F2□□E1-□□-JQ

**MPB19**  
Pushbutton Switches

# MPB19 Series

19mm Metal Pushbutton Switches

## HIGH BUTTON TYPE

**O** Without LED

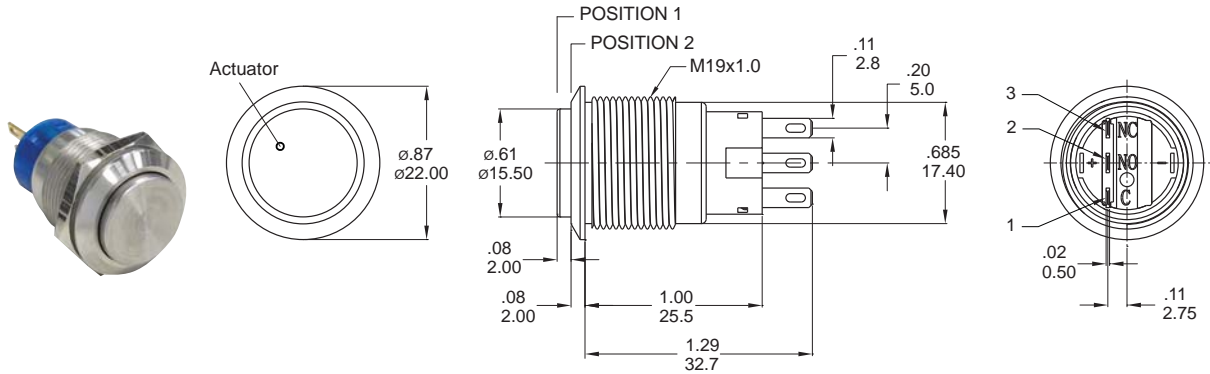

Part No. Shown : MPB19-A0H1□□0-JQ

**R** Ring (Fixed)

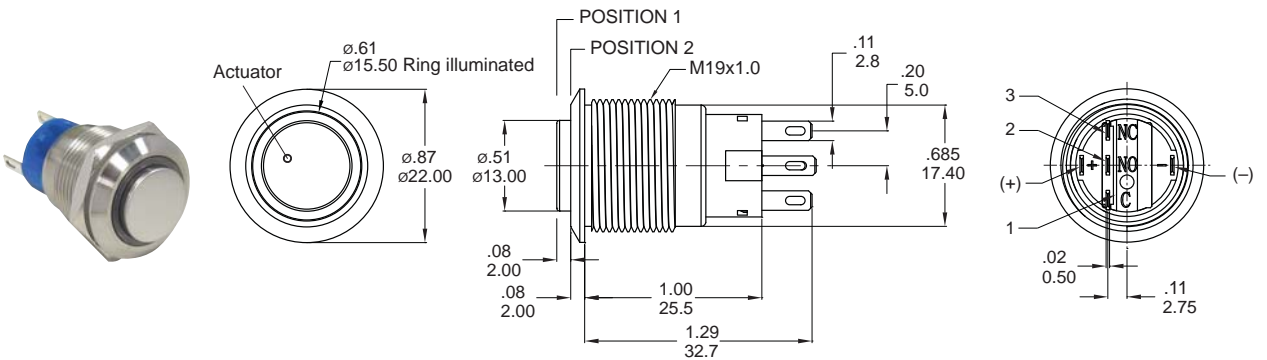

Part No. Shown : MPB19-A0H1□R-□□-JQ

**P** Power logo

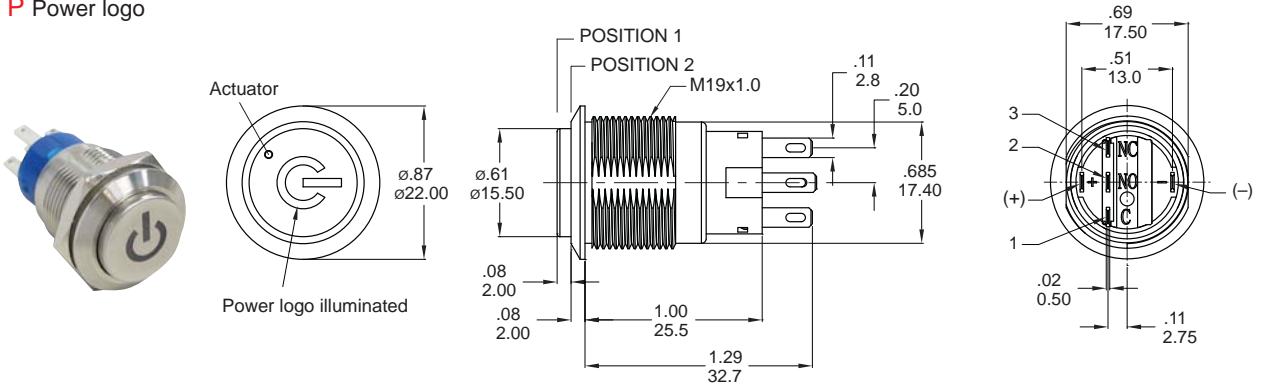

Part No. Shown : MPB19-D0H1□P-□□-JQ

## ROUND BUTTON TYPE

**O** Without LED only

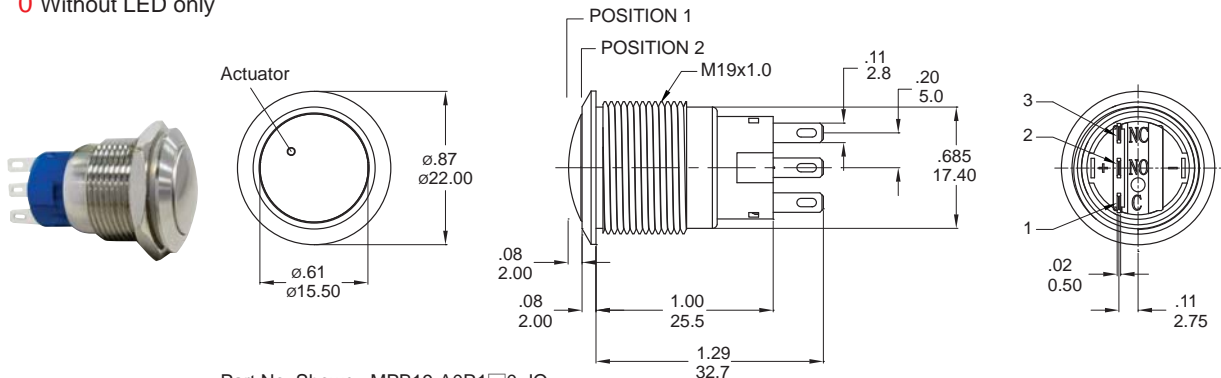

Part No. Shown : MPB19-A0R1□□0-JQ



MPB19 Pushbutton Switches

## TERMINAL TYPE

### J Solder terminal (std)

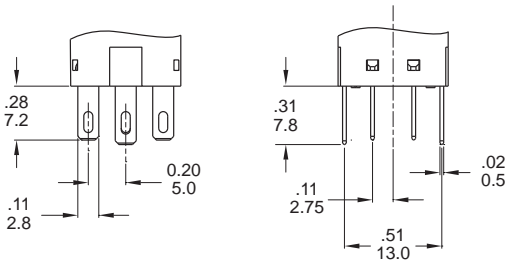

### S2 Short solder terminal

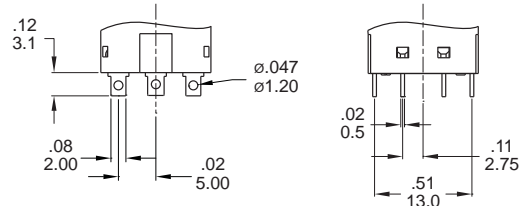

### Wire (Flying lead Terminals)

\* Wire=UL 3385,18AWG,300V(Black/Yellow/Green/Red/Purple)

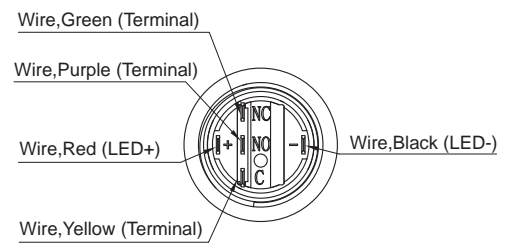
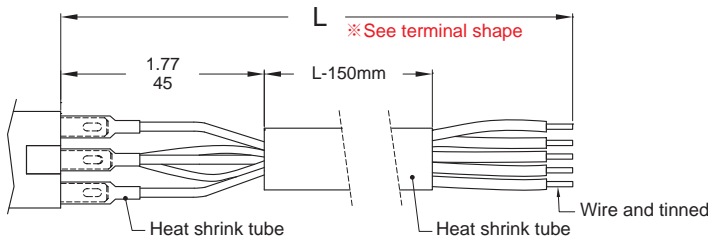

### O/R/D/E Light Type

### P Light Type

### PANEL MOUNTING

Max. Panel thickness: 10.0mm[.39]

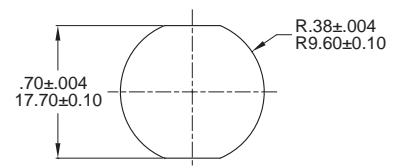
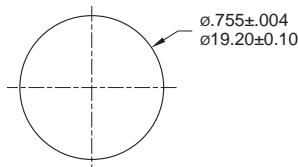

### ASSEMBLED VIEW

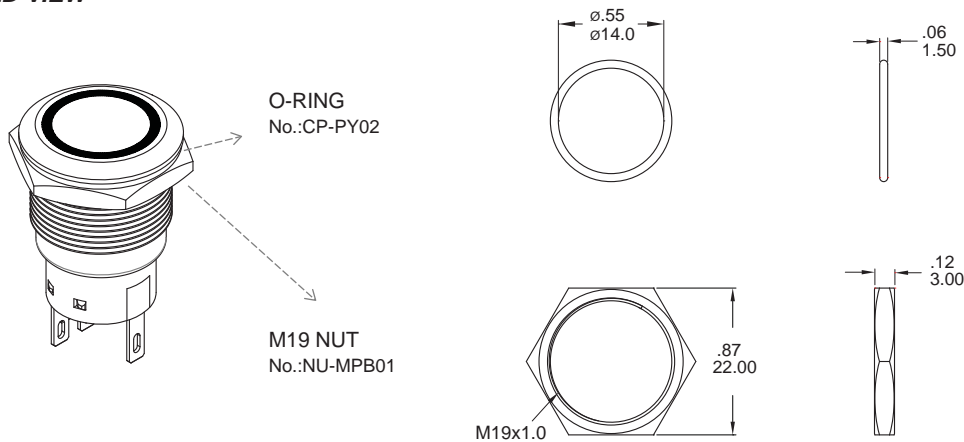

### O-RING INSTALLATION

Proposal	In front of the panel	Behind the panel
Installation Diagram		

MPB19 Pushbutton Switches